

**IVIE Enterprises**

[www.ivie-ent.com](http://www.ivie-ent.com) Ph:(918)254-5161 or (888)262-5161 Fax:(918)250-4807

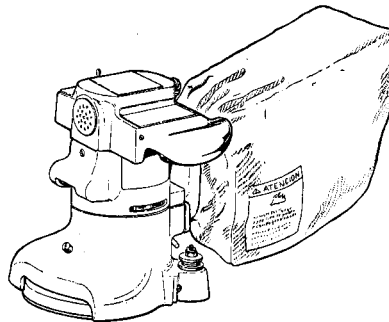

**Operator's  
Manual**



**Super 7R  
Edger**

**READ THIS BOOK**

This book has important information for the use and safe operation of this machine. Failure to read this book prior to operating or attempting any service or maintenance procedure to your American Sanders Technology machine could result in injury to you or to other personnel; damage to the machine or to other property could occur as well. You must have training in the operation of this machine before using it. If you cannot read English, have this manual explained fully before attempting to operate this machine.

Si Ud. no pueden leer el Inglés, se hagan explicar este manual completamente antes de tratar el manejo o servicio de esta máquina.

All directions given in this book are as seen from the operator's position at the rear of the machine.

For new books write to: ALTO U.S. INC., 2100 Highway 265, Springdale, Arkansas 72764.

## Contents of this Book

### **Operator's Manual - Section I**

Operator Safety Instructions .....	3
Machine Specifications .....	5
Sanding Cuts and Sandpaper .....	6
Machine Set-Up .....	7
Operating Instructions .....	7
Adjustment Procedures .....	8
Routine Maintenance .....	8
Carbon Brushes .....	8
Dust Bag .....	8
Bearings .....	8

### **Parts and Service Manual - Section II**

Maintenance .....	10
Wiring Diagram .....	11
Assembly Drawing .....	12
Assembly Parts List .....	13

### **IVIE Enterprises**

[www.ivie-ent.com](http://www.ivie-ent.com) Ph:(918)254-5161 or (888)262-5161 Fax:(918)250-4807

# OPERATOR SAFETY INSTRUCTIONS



**WARNING**



**AVERTISSEMENT**



**ADVERTENCIA**

<b>DANGER</b> means:	Severe bodily injury or death can occur to you or other personnel if the <b>DANGER</b> statements found on this machine or in this Owner's Manual are ignored or are not adhered to. Read and observe all <b>DANGER</b> statements found in this Owner's Manual and on your machine.
<b>WARNING</b> means:	Injury can occur to you or to other personnel if the <b>WARNING</b> statements found on your machine or in this Owner's Manual are ignored or are not adhered to. Read and observe all <b>WARNING</b> statements found in this Owner's Manual and on your machine.
<b>CAUTION</b> means:	Damage can occur to the machine or to other property if the <b>CAUTION</b> statements found on your machine or in this Owner's Manual are ignored or are not adhered to. Read and observe all <b>CAUTION</b> statements found in this Owner's Manual and on your machine.



**DANGER:**

Failure to read the Owner's Manual prior to operating or attempting any service or maintenance procedure to your American Sanders Technology machine could result in injury to you or to other personnel; damage to the machine or to other property could occur as well. You must have training in the operation of this machine before using it. **If you cannot read English, have this manual explained fully before attempting to operate this machine.**



**DANGER:**

















Sanding/finishing wood floors can create an environment that can be explosive. The following safety procedures must be adhered to:

- Cigarette lighters, pilot lights and any other source of ignition can create an explosion when active during a sanding session. All sources of ignition should be extinguished or removed entirely if possible from the work area.
- Work areas that are poorly ventilated can create an explosive environment when certain combustible materials are in the atmosphere, i.e., solvents, thinners, alcohol, fuels, certain finishes, wood dust and other combustible materials. Floor sanding machines can cause flammable material and vapors to burn. Read the manufacturer's label on all chemicals used to determine combustibility. Keep the work area well ventilated.
- Spontaneous combustion or an explosion can occur when working with sanding dust. The sanding dust can ignite and cause injury or damage. Sanding dust should be disposed of properly. Always empty the sanding dust into a metal container that is located outside of any building(s).
- Remove the contents of the dust bag when the bag is 1/3 full. Remove the contents of the dust bag each time you finish using the machine. Never leave a dust bag unattended with sanding dust in it.
- Do not empty the contents of the dust bag into a fire.
- Hitting a nail while sanding can cause sparks and create an explosion or fire. Always use a hammer and punch to countersink all nails before sanding floors.



**DANGER:**

Operating a machine that is not completely or fully assembled could result in injury or property damage. Do not operate this machine until it is completely assembled. Keep all fasteners tight. Keep adjustments according to machine specifications.

-  **DANGER:** Electrocutation could occur if the machine is used on a power circuit that repeatedly trips or is undersized. Have a licensed electrician check the fuse, circuit breaker or power supply.
-  **DANGER:** Electrocutation could occur if maintenance and repairs are performed on a unit that is not properly disconnected from the power source. Disconnect the power supply before attempting any maintenance or service.
-  **DANGER:** Electrocutation could occur if machine is used on ungrounded electrical circuit. Never remove or disable the grounding supply conductor on the electrical cord. Consult an electrician if the grounding conductor is missing or if you suspect your circuit is not grounded properly.
-  **DANGER:** Use of this machine with a damaged power cord could result in an electrical shock. Do not use the machine if the power cord is damaged. Do not use the electrical cord to move the machine.
-  **DANGER:** Electrocutation or injury could occur if the power cord is run over or damaged by the sander. Keep the cord free from under the machine to avoid contact with the sandpaper. Always lift the power cord over the machine.
-  **DANGER:** Moving parts of this machine can cause serious injury and/or damage. Keep hands, feet and loose clothing away from all moving parts of the sander. Disconnect machine from the power source before changing the abrasive, emptying the dust bag, or performing any maintenance. Do not operate unless all covers and guards are in place. Never leave machine unattended while motor is running or connected to power source.
-  **WARNING:** Failure to read and observe all safety statements found on your machine or in this Owner's Manual can result in serious injury or damage. Read and observe all safety statements. Make sure that all labels, decals, warnings, cautions, and instructions are fastened to the machine. Get new labels from your authorized American Sanders Technology distributor.
-  **WARNING:** Sanding dust can be airborne and can be breathed in while operating a sander. Always wear a dust mask while operating sanding equipment.
-  **WARNING:** Injury to the eyes and/or body can occur if protective clothing and/or equipment is not worn while sanding. Always wear safety goggles, protective clothing, and a dust mask while performing any sanding operation.
-  **WARNING:** Bodily injury could occur if power is applied to the machine with the power switch already in the "ON" position. Always check to assure that the power switch is in the "OFF" position before applying power to the power cable.
-  **WARNING:** Any alterations or modifications of this machine could result in damage to the machine or injury to the operator or other bystanders. Alterations or modifications not authorized by the manufacturer voids any and all warranties and liabilities.
-  **CAUTION:** Maintenance and repairs performed by unauthorized personnel could result in damage or injury. Maintenance and repairs performed by unauthorized personnel will void your warranty. Servicing of this unit must always be referred to an authorized American SandersTechnology distributor.
-  **CAUTION:** Use of this machine to climb on could result in injury or damage. Do not use this machine as a step or furniture.
-  **CAUTION:** Damage could occur to the machine if not properly kept in a dry building for storage. Store the machine in a dry building.
-  **CAUTION:** Serious damage to the floor can occur if the machine is left running in one spot while the sanding disc is in contact with the floor. To avoid damage to the floor, do not dwell while lowering or raising the sanding disc. Always sand with a constant motion and pressure.
-  **CAUTION:** Do not rest machine on sanding disc. To do so may cause a flat spot and reduce the quality of performance. Tip machine back or rest on side when not in use.

**AMERICAN SANDERS TECHNOLOGY  
Model Super 7R  
Specifications**

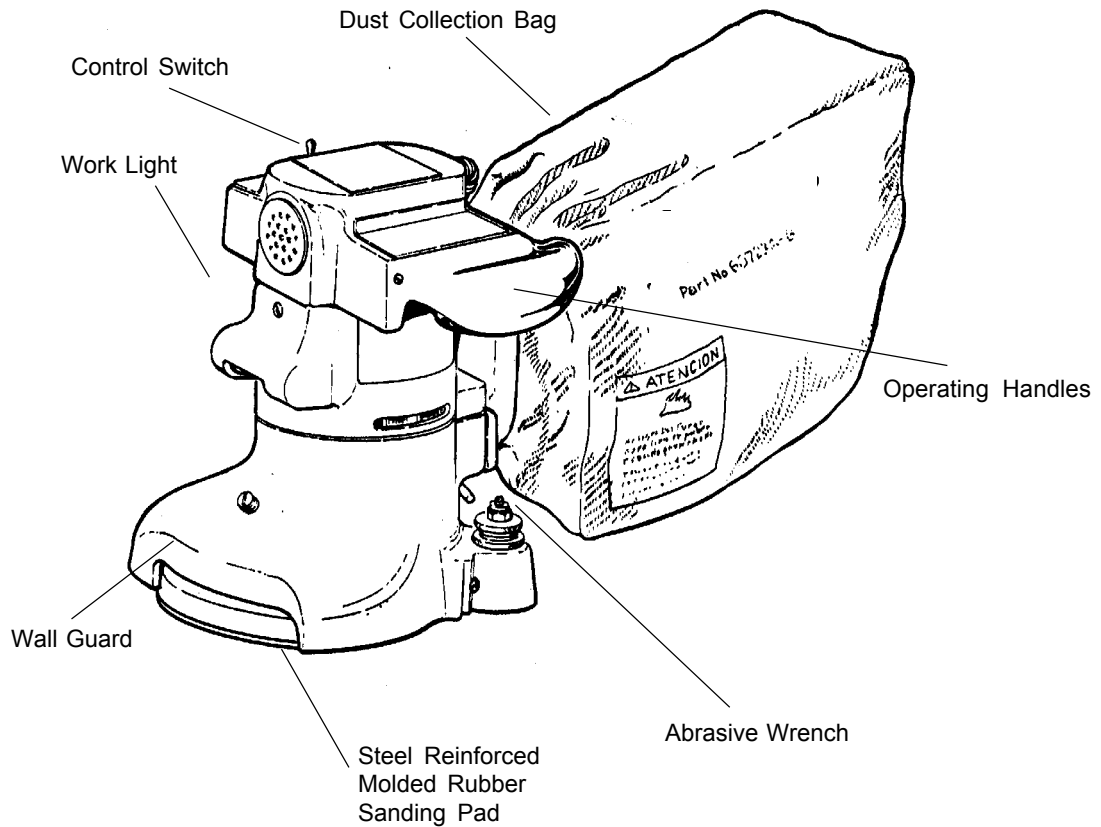

**Specifications**

<b>Model</b>	07011A	07075A	07054A
<b>Electrical Rating</b>	115V, 12.0 A, 50-60 Hz	115V, 12.0 A, 50-6- Hz	230V, 6.0A, 50-60 Hz
<b>Storage Case</b>	Optional	Standard	Standard
<b>Motor</b>	1hp		
<b>Abrasive Size</b>	7" x 7/8" Dia. Disc		
<b>Disc Rate</b>	2800 RPM		
<b>Disc Driver System</b>	Gear Driven		
<b>Power Cable</b>	14-3 Gray Rubber		
<b>Dust Collection</b>	Standard		
<b>Dust Control Rate</b>	110 CFM		

**IVIE Enterprises**

[www.ivie-ent.com](http://www.ivie-ent.com) Ph:(918)254-5161 or (888)262-5161 Fax:(918)250-4807

## SANDING CUTS AND SANDPAPER

### Initial Cut

The purpose of the initial cut is to remove old finish and gross imperfections on the floor surface. A coarse abrasive should be used.

If glazing, loading, or burning takes place immediately into an initial cut, select a coarser abrasive. If this should occur during an initial cut, the abrasive has dulled and must be replaced.

### Final Cuts

The purpose of a finishing cut is to remove the scratches produced during the initial cut. Use a fine (60 - 80 grit) grain abrasive.

If the surface remains rough after a finishing cut, it may be necessary to use an even finer grain of abrasive (80 - 100 grit). Care should be taken in selecting the grit size of the abrasive. A very fine grain will close the pores on a wood floor making admission of a stain difficult.

Grain	Use	7" Diameter Standard Grade Part #/Qty	7" Diameter Professional Grade Part #/Qty
12 grit 16 grit 20 grit 24 grit	For removing gross imperfections and restore evenness to old flooring. To remove build-up of paints and varnishes.	945300/50 945301/50 945302/50	945594/200 945595/200 945596/200 945597/300
30 grit 36 grit	For first sanding of new flooring (maple, oak). For removing minor imperfections and finishes from old flooring.	945305/100	945598/300 945599/300
40 grit	For initial cut on new flooring (oak, walnut). For removing minor imperfections and finishes from old flooring.		945600/300
50 grit	For first sanding of new flooring (cedar, pine, fir) For clean-up of 16 grit.	945307/100	945601/300
60 grit	For clean-up from initial cut 36 grit.	945308/100	945602/300
80 grit	For final sanding of certain hardwoods. For clean-up of initial cuts (50 grit).	945309/100	945603/300
100 grit	For final sanding of certain hardwoods and conifers where a smooth surface is desired.	945310/100	945604/300
120 grit	For final sanding of certain conifers.		945605/500
150 grit	For final sanding of certain conifers where a smooth surface is desired for surface roughening between coats of finish.		945606/300

### IVIE Enterprises

[www.ivie-ent.com](http://www.ivie-ent.com)

Ph:(918)254-5161 or (888)262-5161 Fax:(918)250-4807

## MACHINE SET-UP

1. Familiarize yourself with the machine. Read all danger, warning, and caution statements and the Owner's Manual before operating this machine. If you or your operator cannot read English, have this manual explained fully before attempting to operate this machine.
2. Install dust bag support to the exhaust bracket (figure 1). Place opening of dust bag over dust bag support and exhaust bracket; cinch and tie securely to exhaust bracket.
3. Remove screw and abrasive retainer. Center abrasive on pad and secure with abrasive retainer and screw. (Figure 2)
4. Return machine to upright position and tilt machine back on casters until it comes to rest on the exhaust bracket. Machine will be in a reclined position. Do not allow machine to rest on pad especially after use, or compression set may take place within elastomer on pad. This will create a flat spot and bounce during use. (Figure 3)

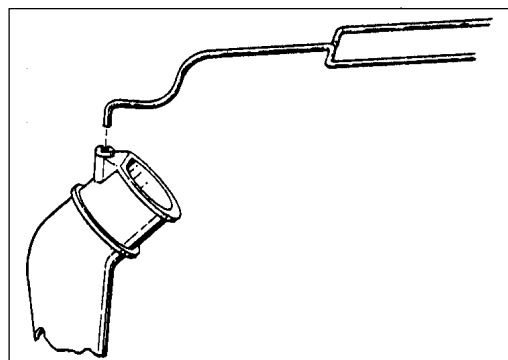

Figure 1

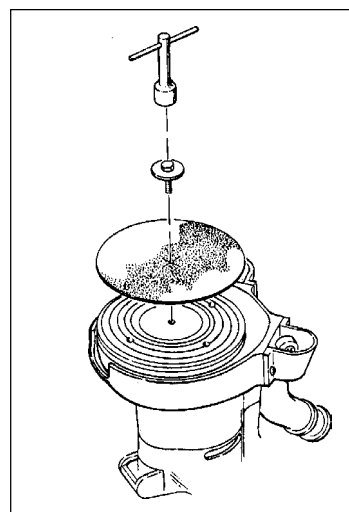

Figure 2



**WARNING:** Bodily injury could occur if power is applied to the machine with the power switch already in the "ON" position. Always check to assure that the power switch is in the "OFF" position before applying power to the power cable.

2. Make sure the control switch is in the "Off" position then connect the supply cable to an appropriately grounded fused circuit. For machines that are equipped with a motor pigtail, connect the supply cable to the motor pigtail. (Figure 4)
3. With the machine in the reclined position firmly grasp both handles and flip the control switch to the "ON" position. (Figure 3.)
4. Gradually lower pad to surface intended for sanding. Make sure the machine is in motion while the pad is engaged with the surface to be sanded. You may use broad circular motion as you sand along the length of the surface or you may use a combination of forward and sideward motions. In time you will develop your own technique to optimize coverage and dust recovery. It is advisable to not add effort to the pad as this may lead to "nosing in" or "tipping" which produces grooves or lines on the surface.
5. When replacing abrasive, emptying the contents of the dust bag, or sanding operation is completed, return machine to reclined position, flip control switch to "Off" then disconnect the motor pigtail from the supply cable.
6. Empty dust bag whenever it becomes 1/3 full.

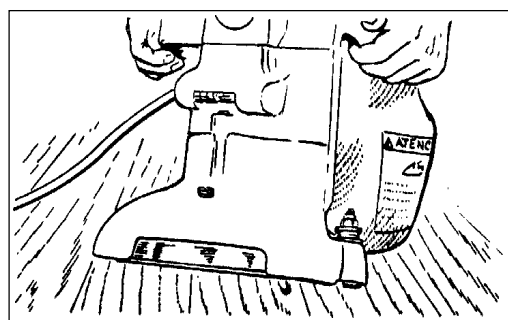

Figure 3

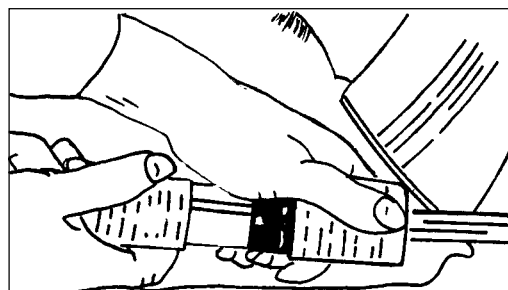

Figure 4

## OPERATING INSTRUCTIONS cont.

**⚠ DANGER:** Failure to disconnect the supply cable from machine whenever servicing, replacing abrasive, or emptying the dust bag could result in electrocution or severe injury. Never leave machine unattended while the supply cable is connected.

**⚠ DANGER:** Never leave dust bag unattended with sanding dust in it. Sanding dust can spontaneously ignite and cause a fire or explosion. Empty dust bag into a metal container, clear of any combustibles. Do not empty content into a fire. Do not overfill dust bag.

## ADJUSTMENT PROCEDURES

### Leveling

To level machine: Grasp caster adjusting screw "A" with an appropriate tool (pliers ect.). Using a similar tool, loosen locknut "B" with a counter clockwise motion. (Figure 5).

Condition - Pad creates ridges on both edges or a "hop" is experienced: Rotate both adjusting screws equal amounts clockwise. Tighten locknuts and test on a piece of plywood. Repeat procedure until condition is corrected. We recommend you not exceed 1/8" rotation for each attempt.

Condition - Pad creates a ridge on the tip of the pad: Rotate both adjusting screws counter clockwise, tighten locknuts and test. Repeat procedure until condition is corrected. Use only 1/8 rotation for each attempt.

Condition - Pad creates a ridge on only one side of the pad: Either rotate the adjusting screw of the side effected clockwise or rotate the adjusting screw opposite counter-clockwise, depending on whether the ridge terminates beyond the tip of the pad or prior to it. If it is prior to the tip, adjust the side effected, otherwise adjust the opposite side.

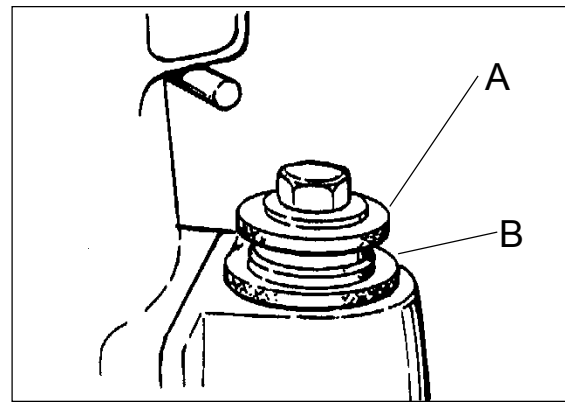

Figure 5

## ROUTINE MAINTENANCE

**⚠ CAUTION:** Failure to perform maintenance at recommended intervals may void warranty.

### Carbon Brushes

Have the carbon brushes replaced at least every 500 hours and more frequently under heavy use.

### Dust Bag

Periodically the dust bag should be turned inside out, shaken vigorously and machine washed in cold water to prevent pore blockage and loss of dust control.

### Bearings

To insure reliable performance, have armature and pad driver bearings inspected for wear or damage after every 1500 hours. If used heavily, have the bearings replaced seasonally.

### Lubrication

The machine comes fully lubricated. The gears in the gear box have enough lubrication for approximately six months of normal operation. Have the lubricant changed at least every 6 months or more frequently under heavy use.